

Pop Pet

Build Instructions

30 minutes approximate build time

<15 Years, Recommended Parental Supervision

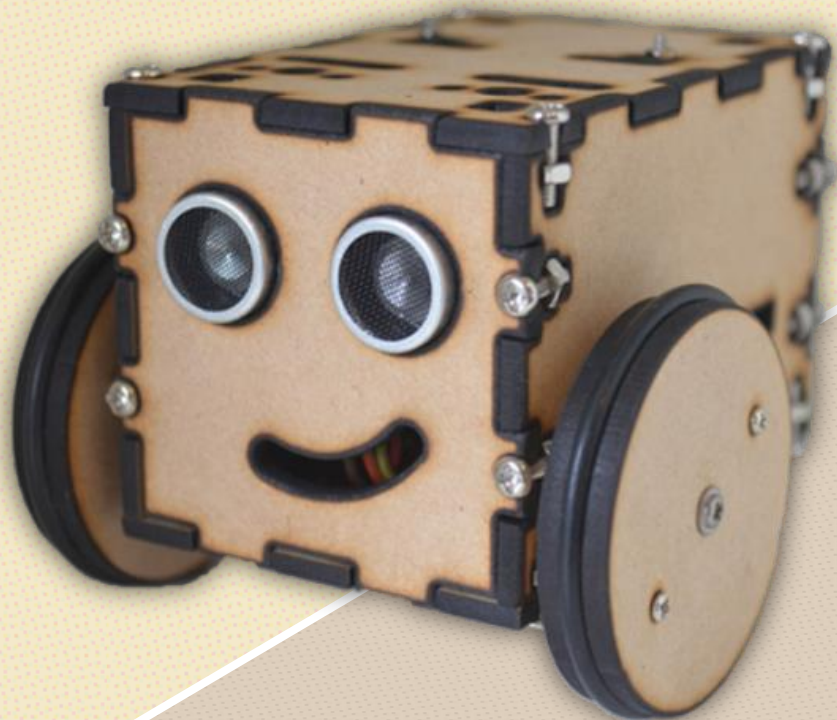











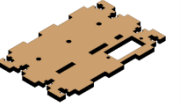
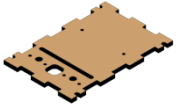



Parts List

Missing Something?
 Send us an email at:
Support@PopPetTheRobot.com

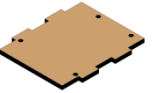
- Brain (Mini Driver)  1x
- Motor (Little Black Duck)  2x
- Distance Sensor (HC-SR04)  1x
- Battery Holder  1x
- *Castor Wheel  1x
- *Castor Spacer  2x
- Tyre (O-Ring)  2x

- M3X10  16x
- M3X5  4x
- M3 Nut  16x
- M2X12  8x
- M2X8  2x
- M2 Nut  10x
- Spacer  2x
- *M2.5X12  2x
- **M2X8 (Self Tapping)  2x

- Bottom Plate  1x
- Left Plate  1x
- Right Plate  1x
- Top Plate  1x
- Face Plate  1x
- Rear Plate  1x
- Switch Key  1x
- Wheel Inner  2x
- Wheel Middle  2x
- Wheel Outer  2x

- Board Plate  1x
 - Screwdriver  1x
 - **Servo  2x
 - Horn  2x
 - Nylon Screw  4x
 - Nylon Nut  4x
 - Nylon Spacer  4x
- Used in Advanced kit

*Included in Castor bag

**Included in Servo bags

Advanced Kit Extras

In the Advanced Kit only

Microphone Module 1x

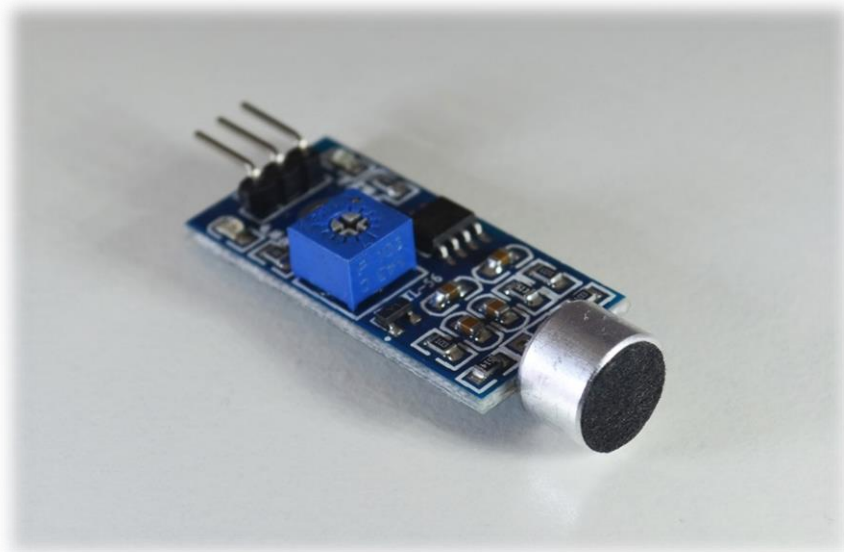

Light Module 2x

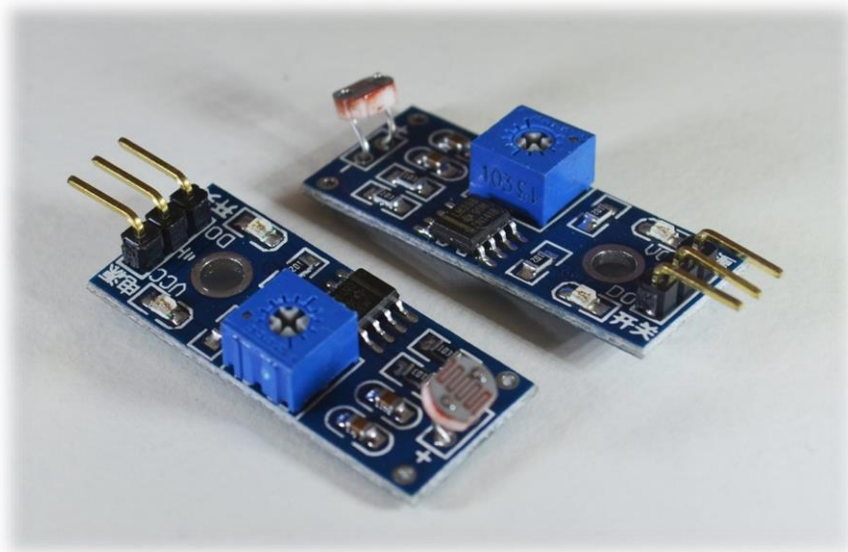

Bottom Piece Assembly

M2 2x



M2X12 2x



1x



2x

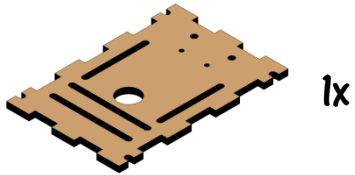

1x

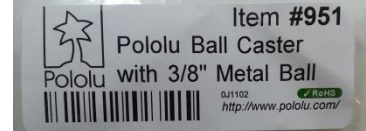
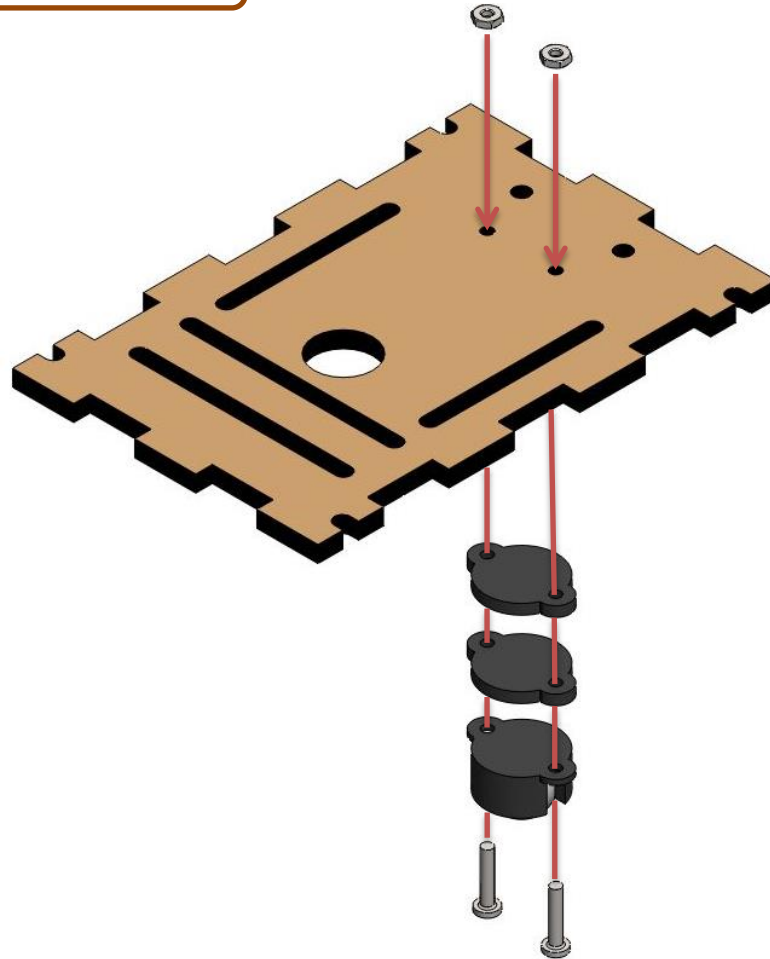

Use screws and nuts from this bag.

Bottom Piece Assembly

M3X5



2x

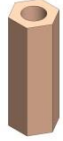

2x

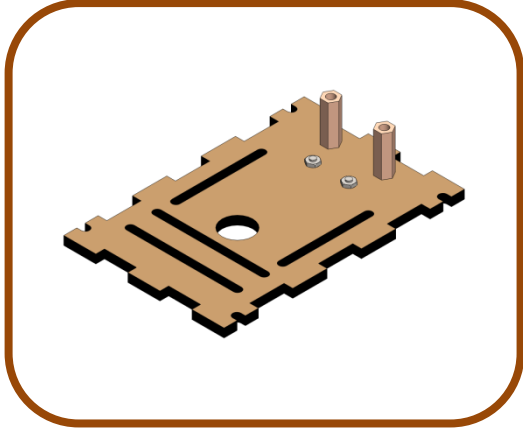
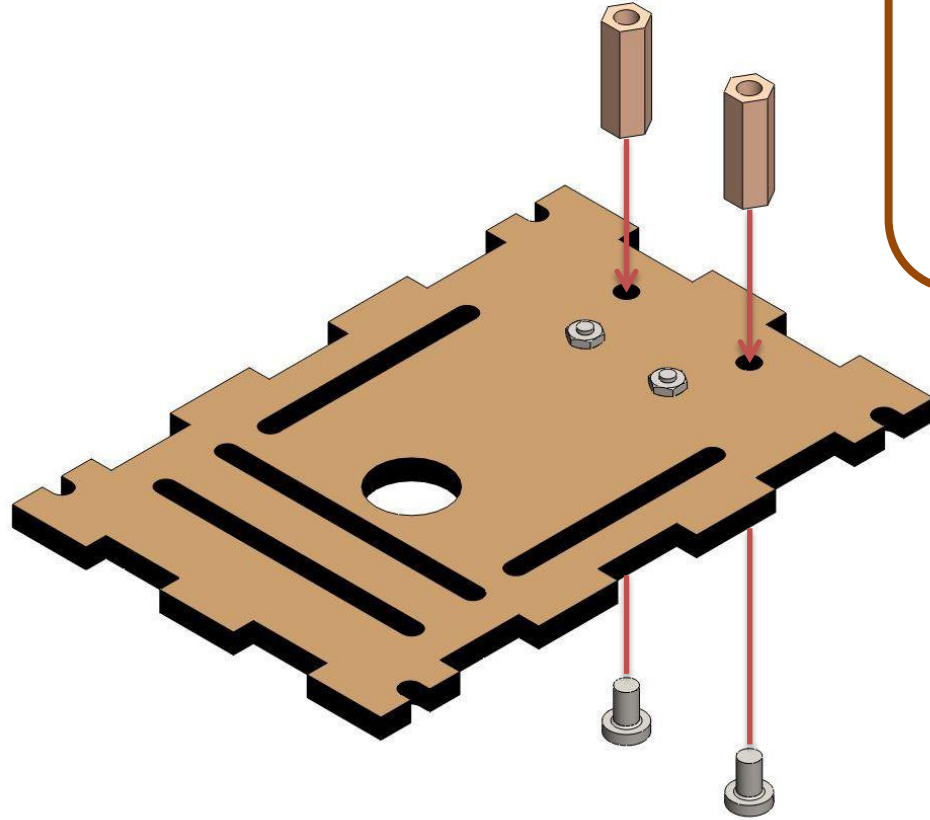

Left Piece Assembly

M2 2x



M2X12 2x



1x



1x

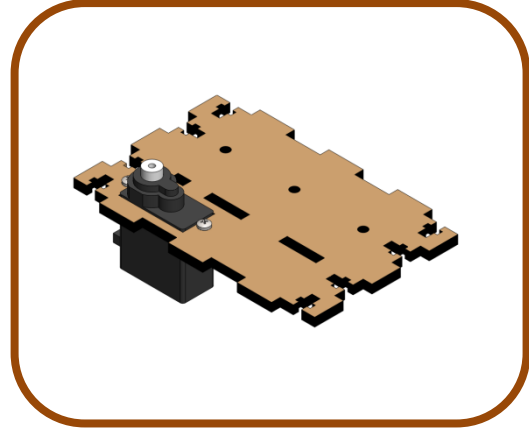
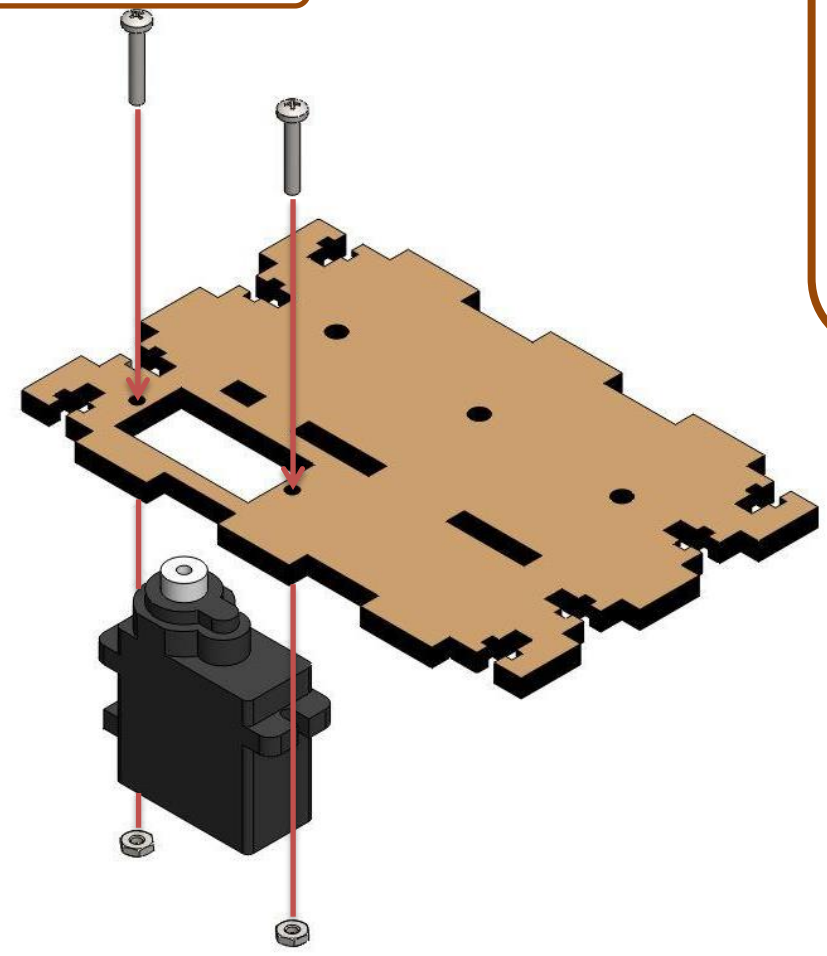
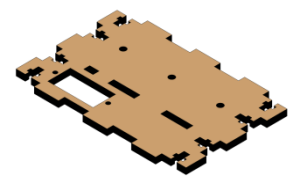

Right Piece Assembly

M2 2x



M2X12 2x



1x



1x

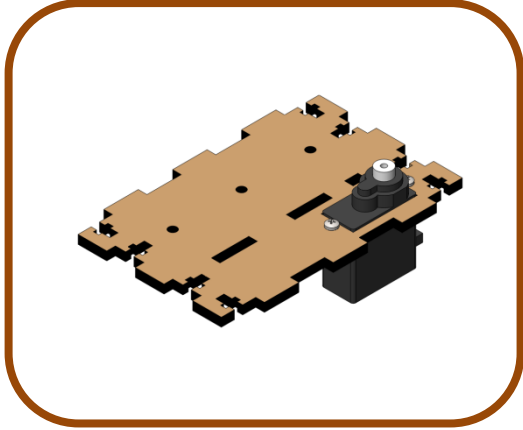
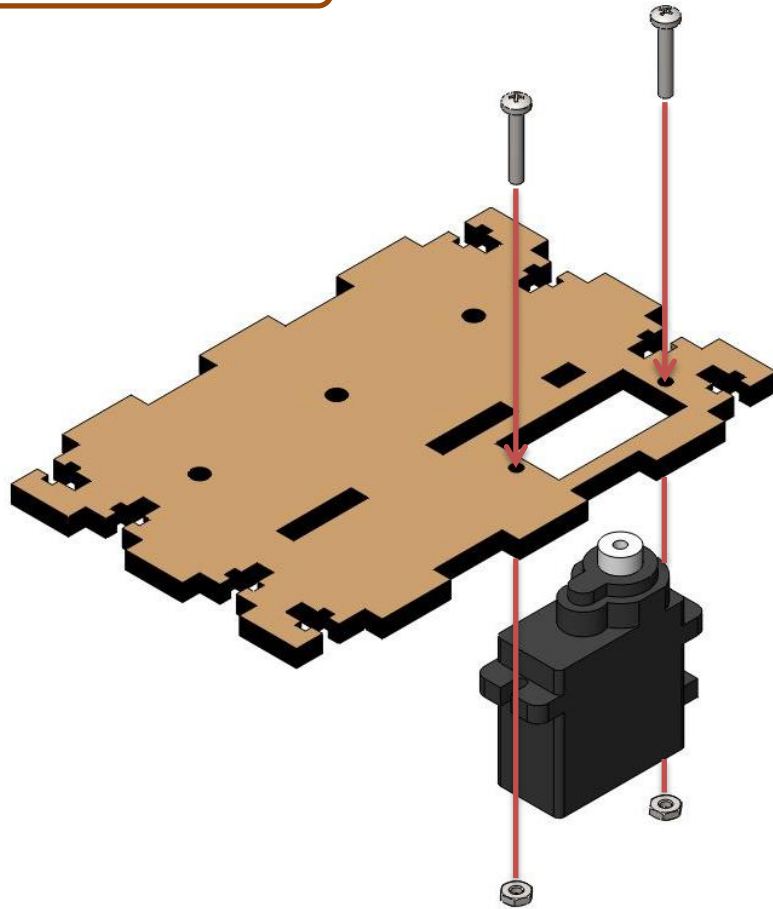
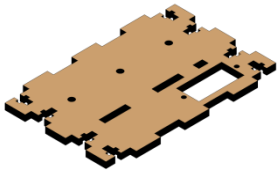

Wheel Assembly

M2 4x



M2X12 4x



2x



2x

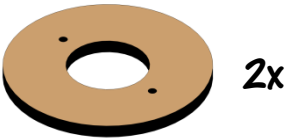

2x

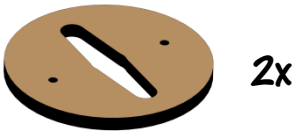

2x

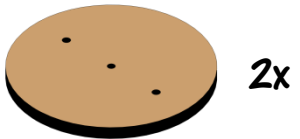

2x

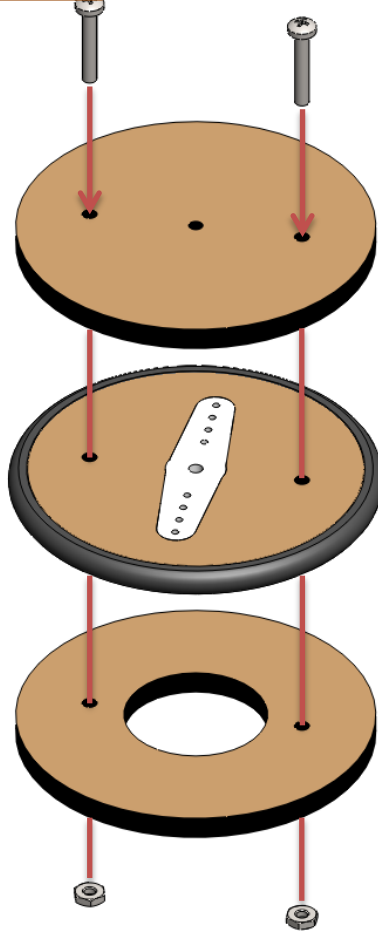

2x

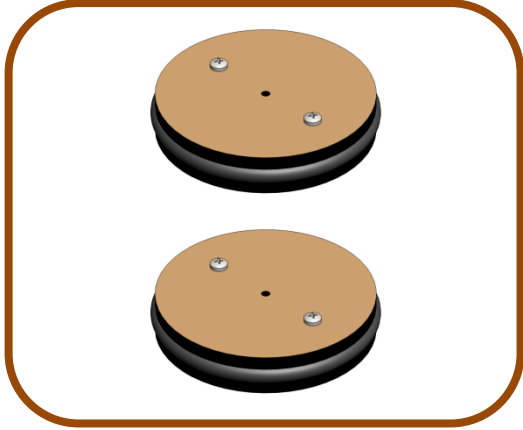

Top Piece Assembly

M2 2x



M2X8 2x

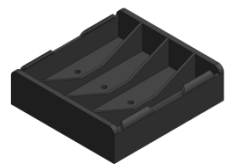

1x

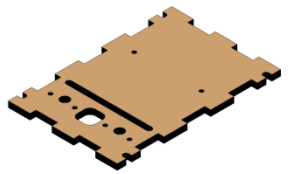

1x

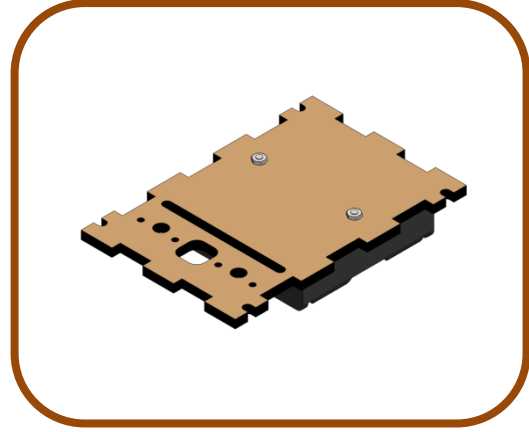
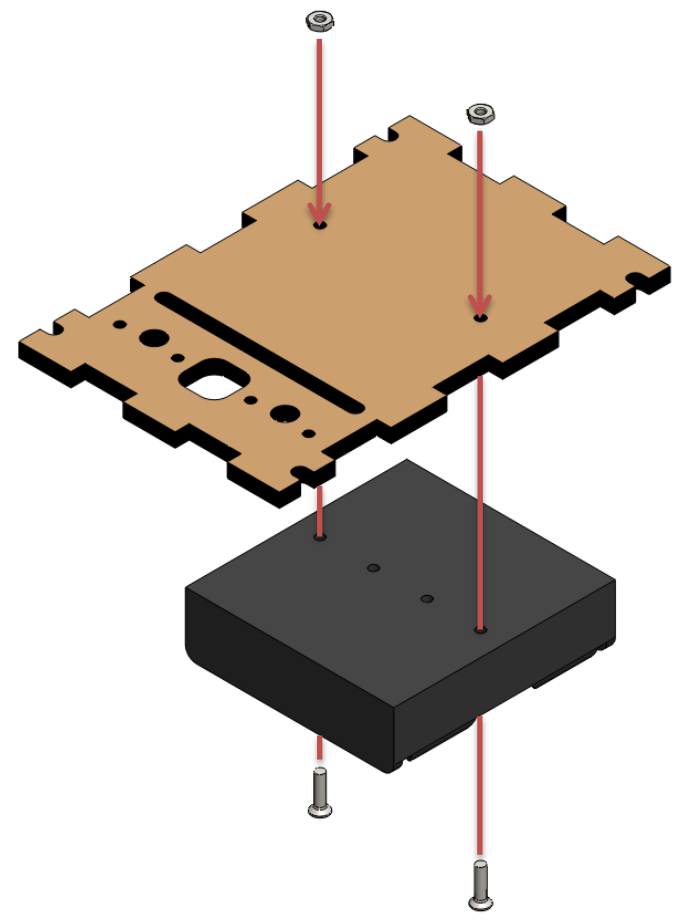

Insert 4X AAA Batteries

Attaching Left piece to Bottom Piece

M3



2x

M3X10



2x

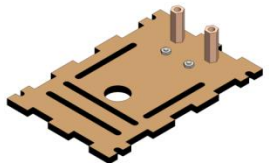

1x

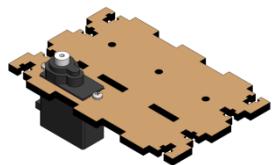

1x

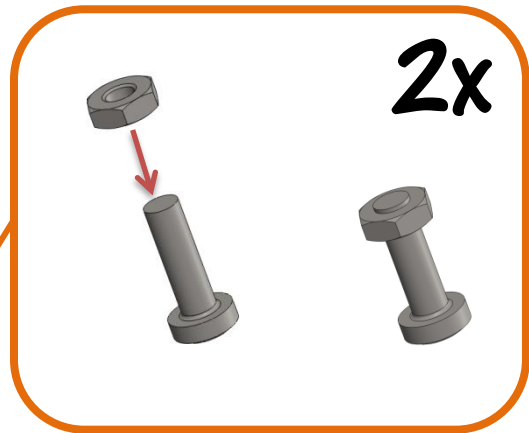
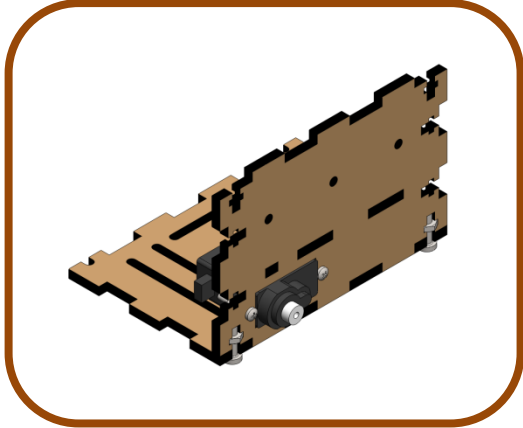
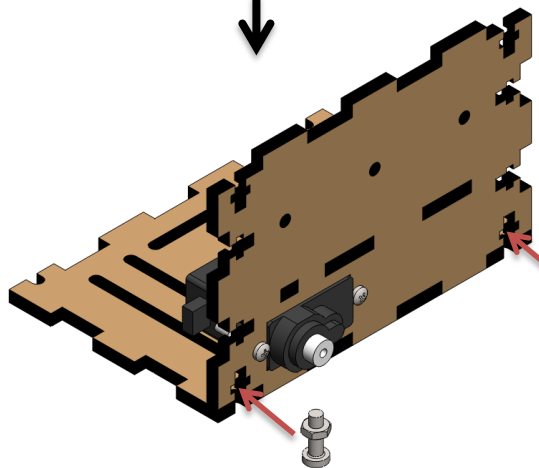
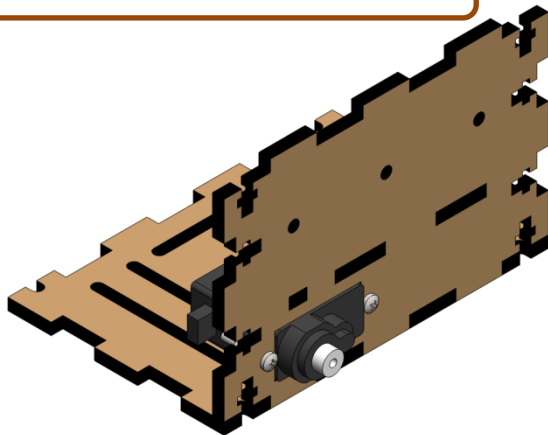

Attaching Right piece

M3 2x



M3X10 2x

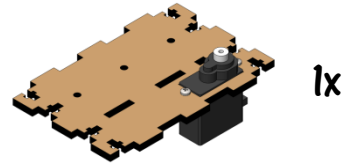

1x

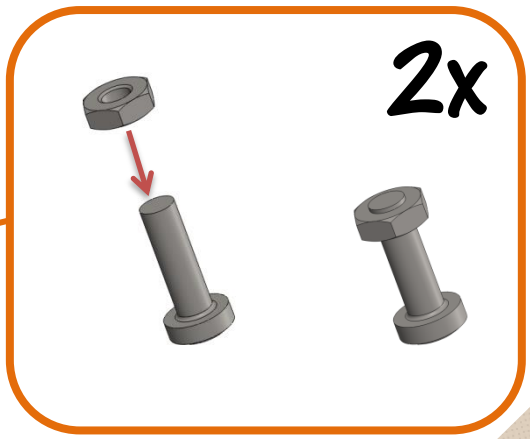
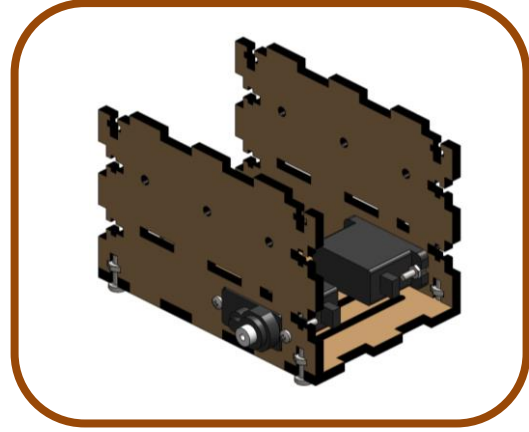
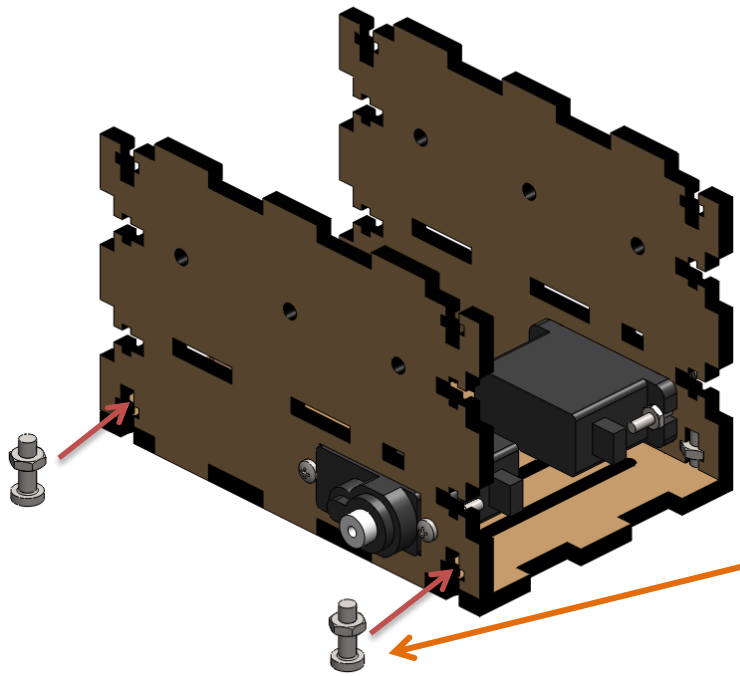

Attaching Face Plate

M3 4x



M3X10 4x

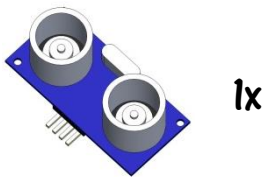

1x

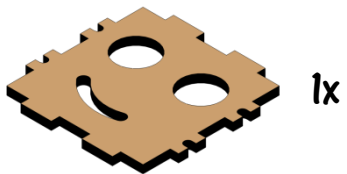

1x

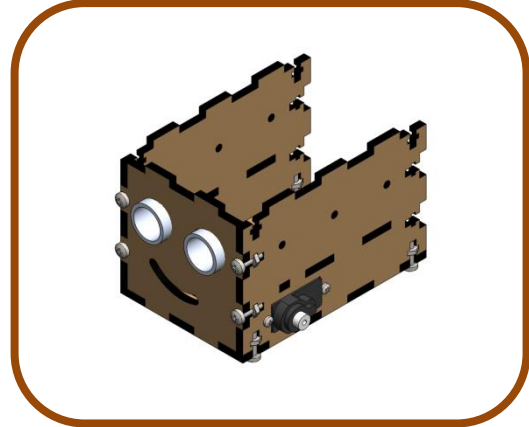
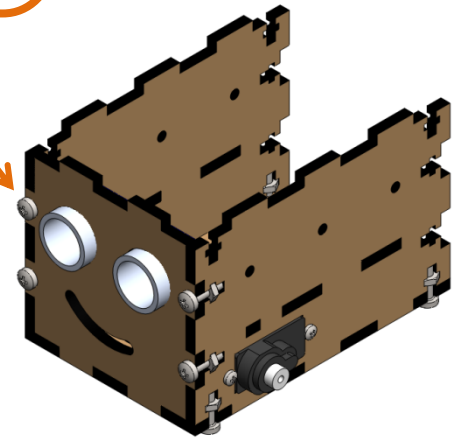
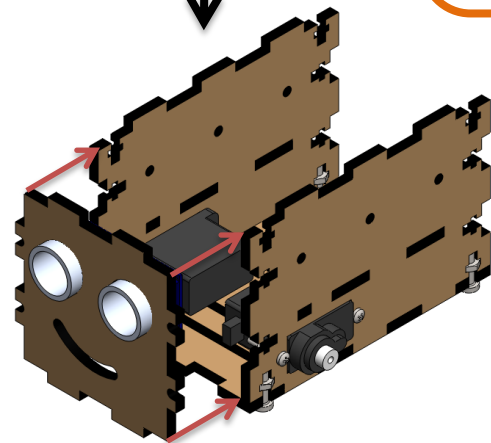
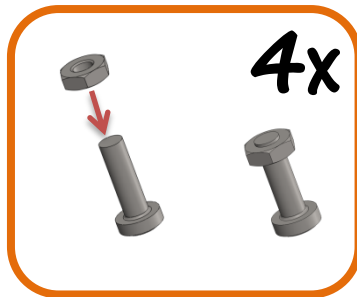
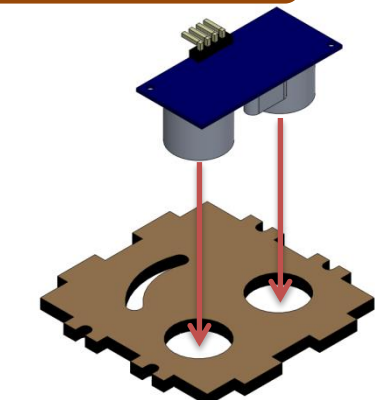

Attaching Mini Driver

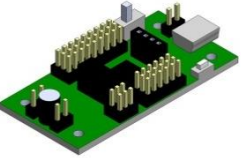
- M3X5  2x
-  1x

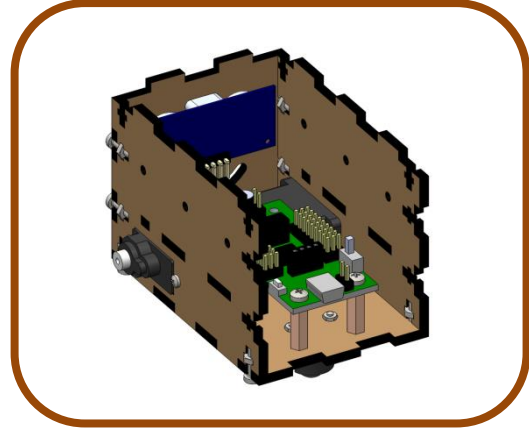
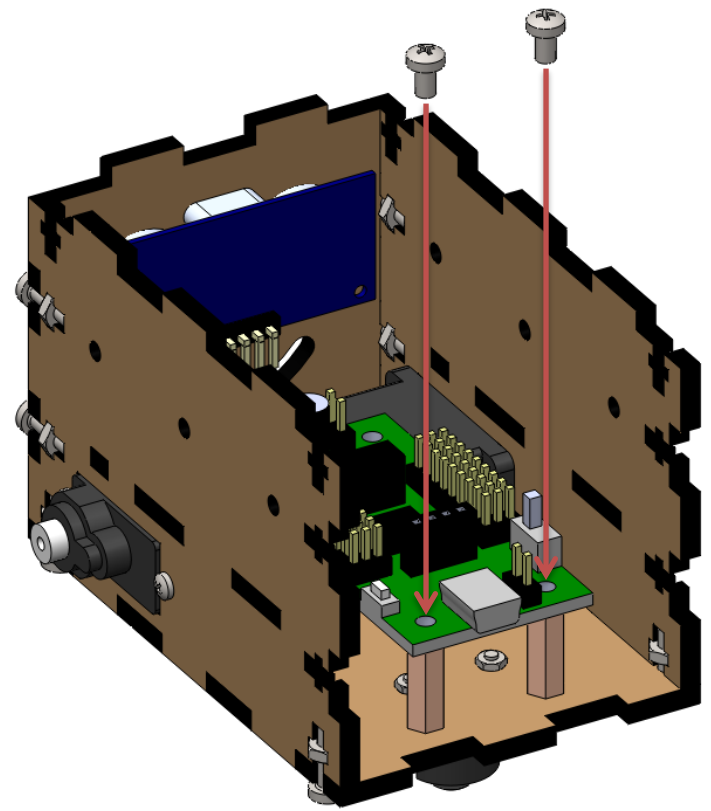

Attaching Rear piece

M3



4x

M3X10



4x



1x



1x

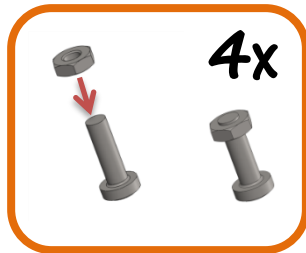
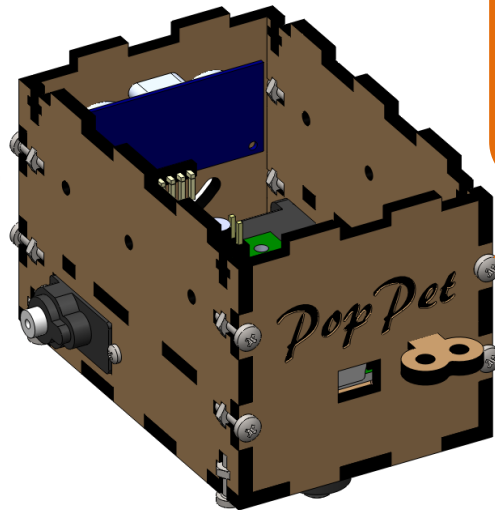
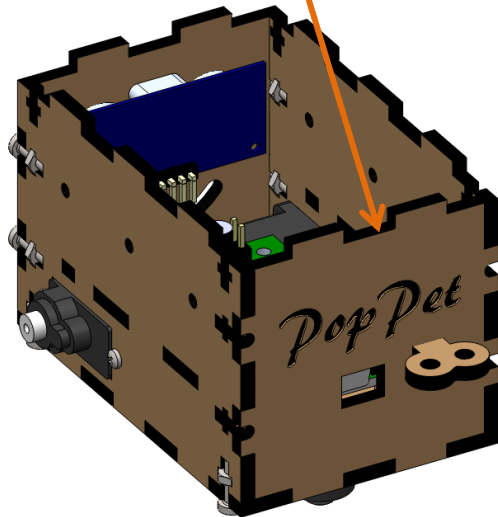
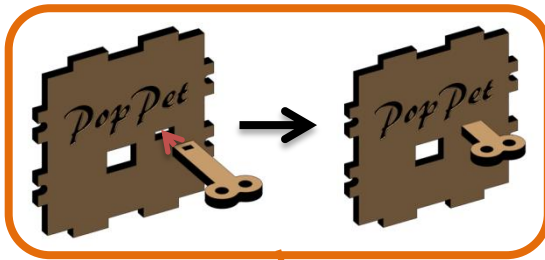

4x

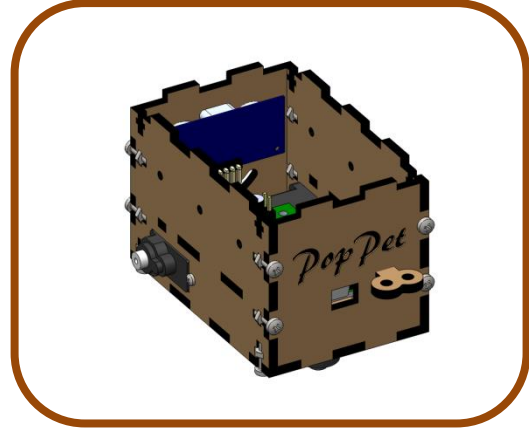

Standard Kit

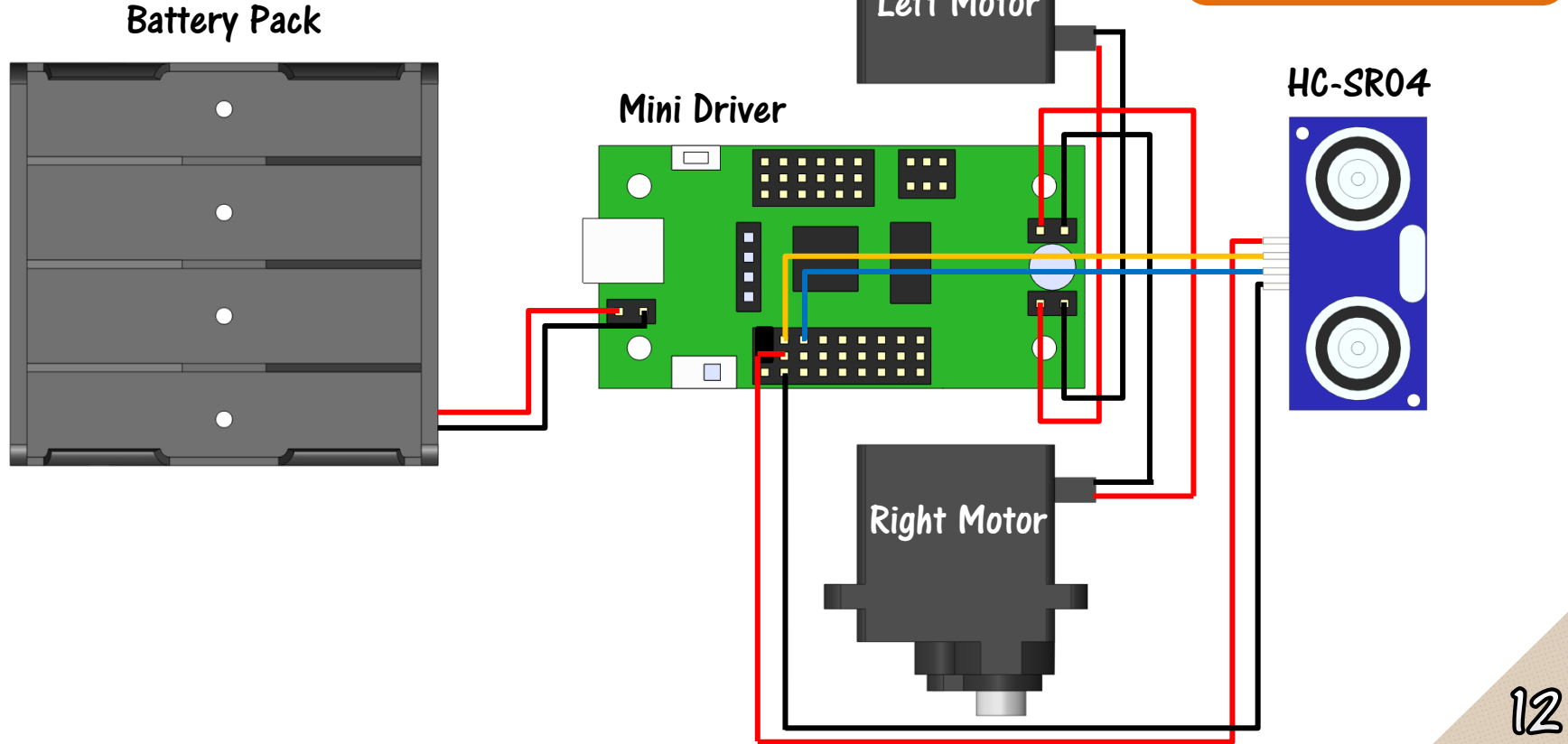

Attaching Advanced Sensors

Advanced Kit

Nylon Screw



3x

Nylon Nut



3x

Nylon Spacer



3x

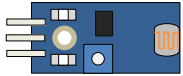

2x

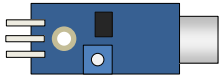

1x

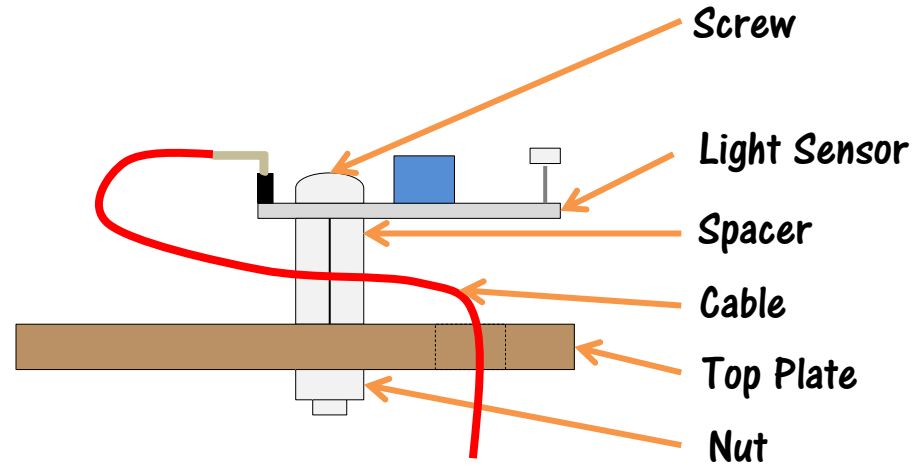
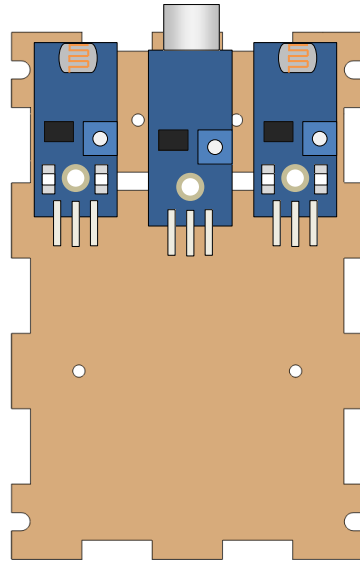

Advanced Kit

Same as the Standard, but with the following extras

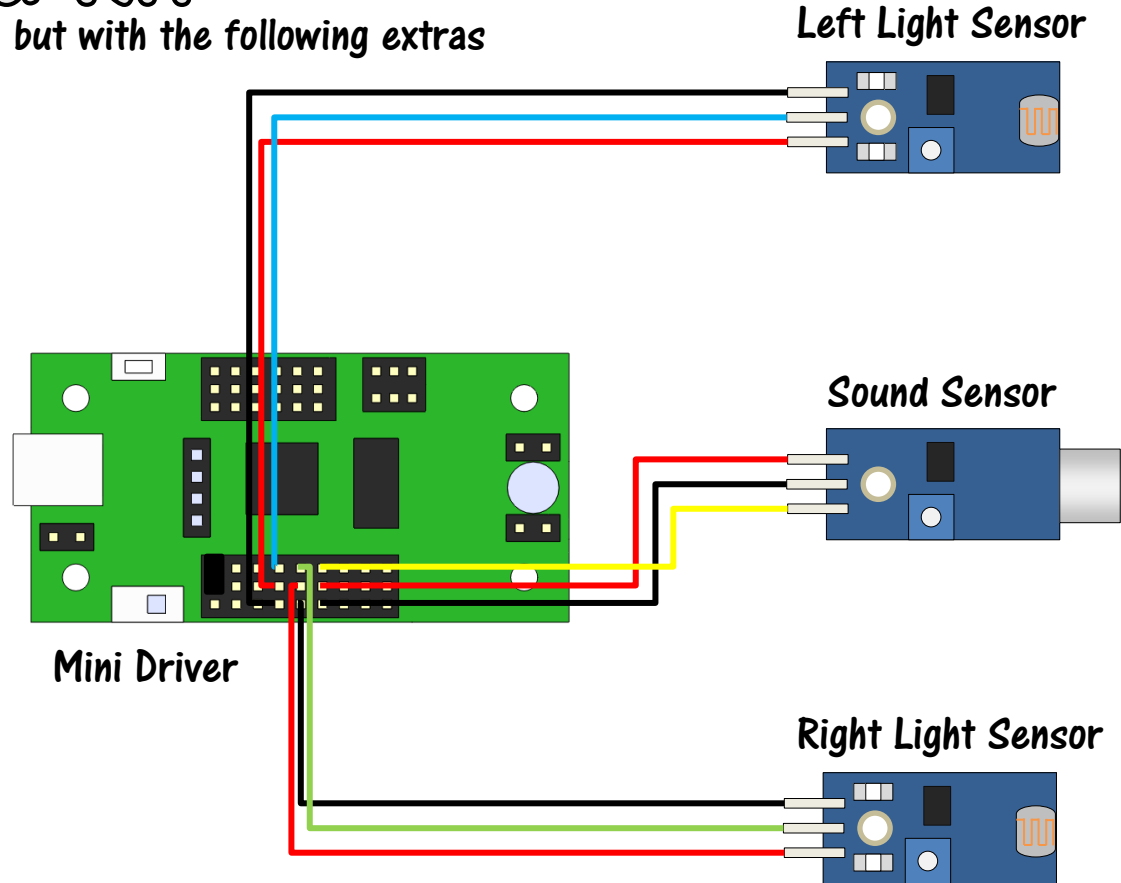
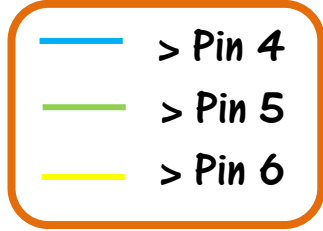

Attaching Top piece

M3 4x



M3X10 4x

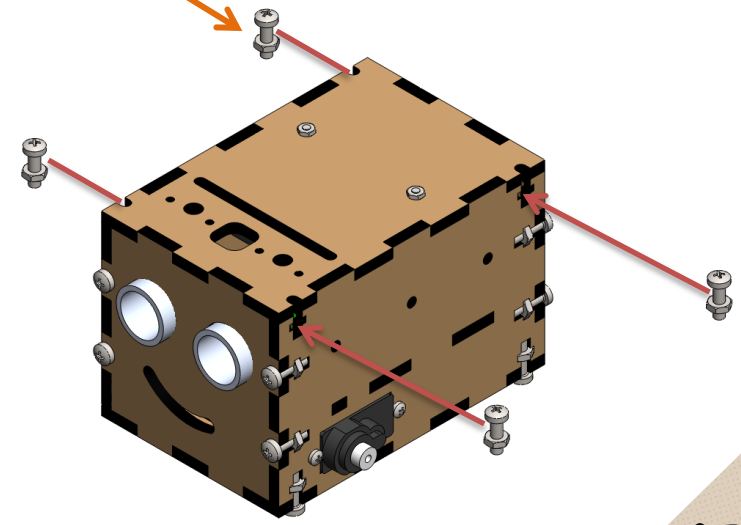
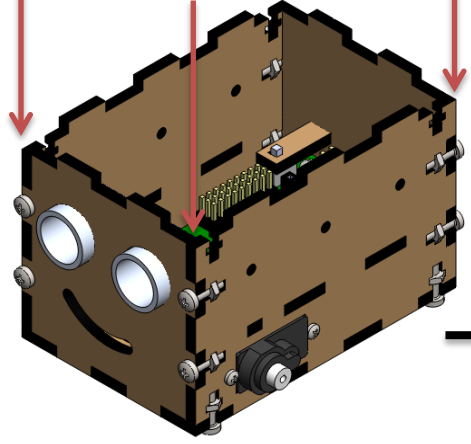
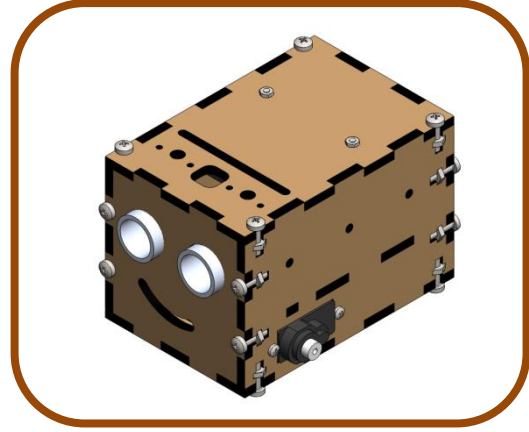
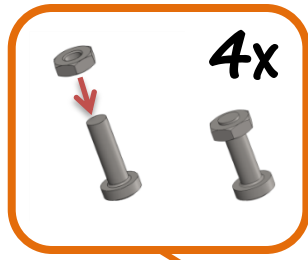
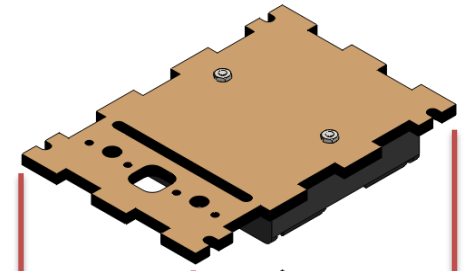
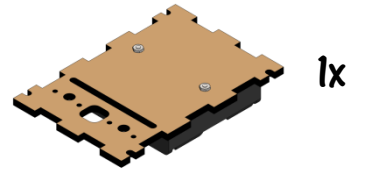

Attaching Left Wheel

M2X8 1x

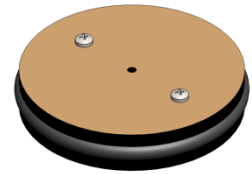

1x

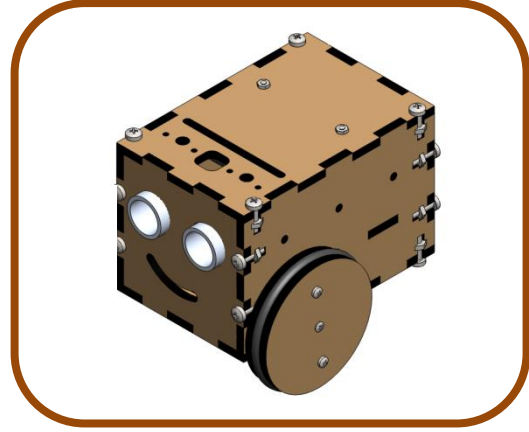
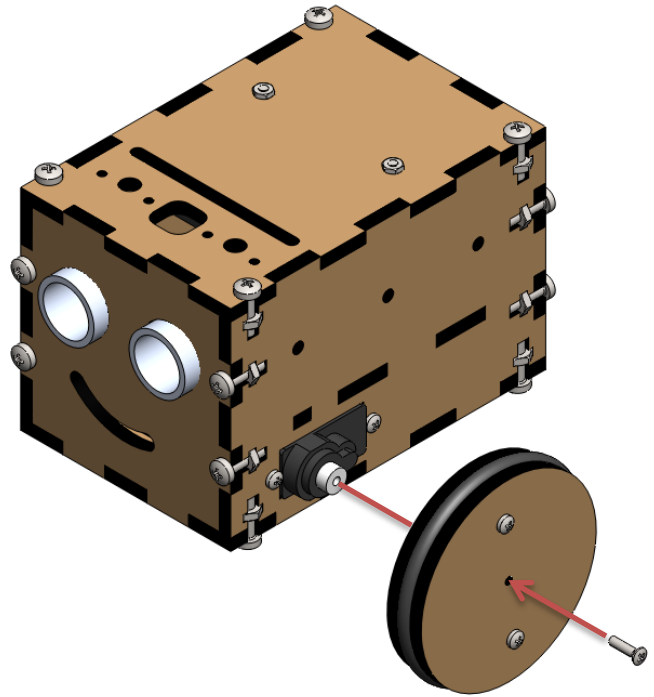

Attaching Right Wheel

M2X8 1x

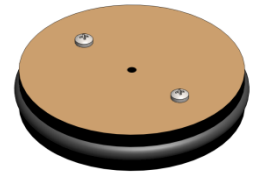

1x

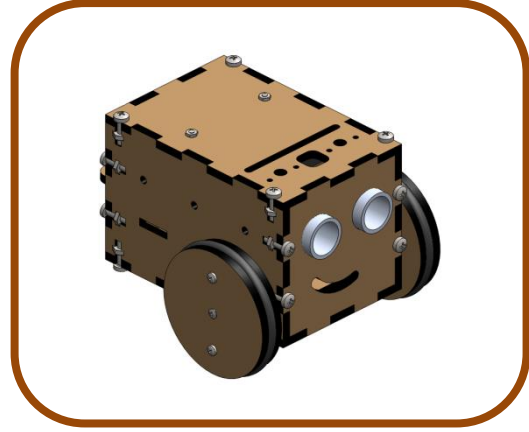
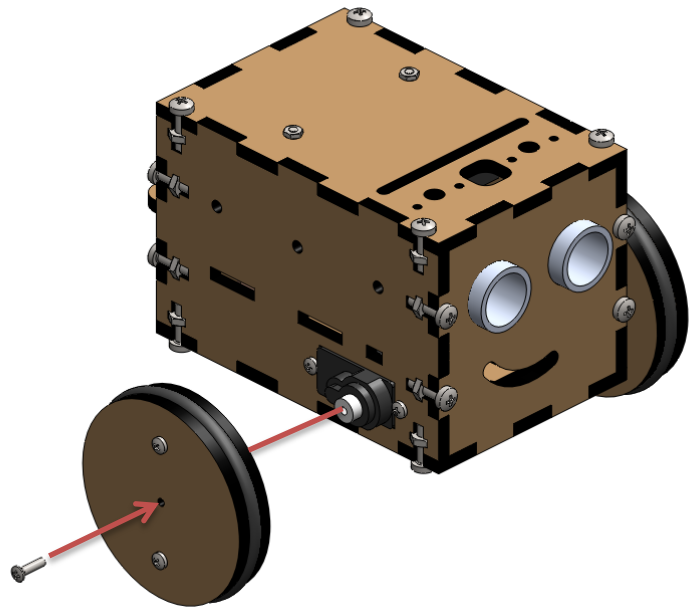

Finished!

1. To turn PopPet on, pull key outwards until you feel a 'click' and the key won't come out any further.
2. After a few seconds PopPet will operate.

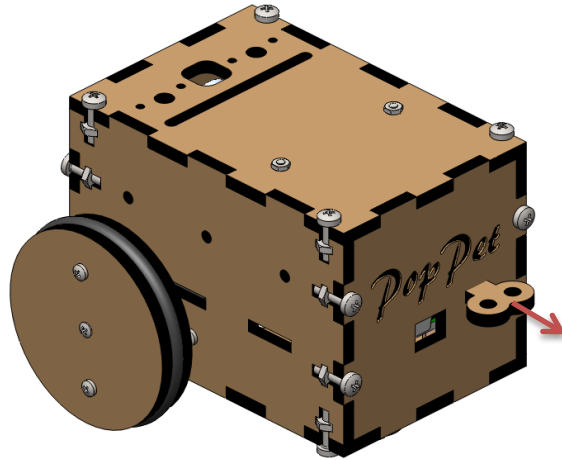

Need Help?

Madada kī zarūrata hai?

Hulp Nodig?

Hai bisogno di aiuto?



Join the forums at:

Mañcōm para śāmila hōm:

Word lid van de forums op :

Iscriviti al forum a :

PopPetTheRobot.com/forums

Or Contact us at:

Yā phira hama para samparka karēm:

Of neem contact met ons op via:

O contattarci all'indirizzo :

Support@PopPetTheRobot.com